

SMWC85 SERIES

85W Single Constant Current Output LED Driver



- Wide Input Voltage 90 to 305VAC, 47 to 63Hz
- Over Voltage / Short Circuit / Over Temperature Protection
- High Efficiency (up to 90%), Active Power Factor Correction (PFC)
- IP67 Waterproof Rating, Fully isolated
- Comply to worldwide safety regulations for lighting
- Cooling by free air convection
- Suitable for LED lighting & moving sign applications, for dry / damp / wet locations

5 Year Warranty

Approvals: IP67  

SPECIFICATION

Part Number		SMWC085-0700SS/D	SMWC085-1400SS/D	SMWC085-1750SS/D	SMWC085-2100SS/D	SMWC085-2800SS/D
OUTPUT	DC VOLTAGE	73-121V	36 -61V	29-49V	24-40V	18-30V
	CONSTANT CURRENT REGION Note.4	700mA	1400mA	1750mA	2100mA	2800mA
	RATED POWER	85W				
	RIPPLE & NOISE(max.) Note.2	3.6V	1.8V	1.5V	1.2V	1.0V
	CURRENT TOLERANCE Note.3	±5.0%				
	LINE REGULATION	±2.0%				
	LOAD REGULATION	±3.0%				
	SETUP, RISE TIME(Typ.) Note.7	1700ms/50ms 115VAC at full load		800ms/50ms 230VAC		
INPUT	VOLTAGE RANGE Note.5	90 ~305VAC				
	FREQUENCY RANGE	47 ~ 63Hz				
	POWER FACTOR(Typ.)	0.99@115VAC 60HZ 0.96@230VAC 50HZ				
	EFFICIENCY(Typ.)	90%	89%	89%	88%	88%
	AC CURRENT(Typ.)	0.91A/115VAC	0.42A/230VAC			
	INRUSH CURRENT(Typ.)	COLD START 50A (Twidth=270us measured at 50% Ipeak) at 230VAC				
	LEAKAGE CURRENT	<0.75mA/265VAC				
PROTECTION	OVER CURRENT Note.4	95 ~ 108% Protection type: Constant current limiting, recovers automatically after fault condition is removed				
	SHORT CURRENT	Hiccup mode, recovers automatically after fault condition is removed				
	OVER VOLTAGE	127V	64V	51V	43V	32V
		Protection type: Hiccup mode, recovers automatically after fault condition is removed				
	OVER TEMP.	Hiccup mode, recovers automatically after fault condition is removed				
ENVIRONMENT	WORKING TEMP.	-35 ~ +70°C (Refer to "Derating Curve")				
	WORKING HUMIDITY	10 ~ 100% RH non-condensing				
	STORAGE TEMP., HUMIDITY	-40 ~ +85°C, 5 ~ 100% RH				
	TEMP. COEFFICIENT	±0.03%/°C (0~50°C)				
	VIBRATION	10 ~ 500Hz, 5G 12min./1cycle, period for 72min. each along X, Y, Z axes				
SAFETY & EMC	SATETY STANDARDS Note.6	UL8750, UL935, UL1012, CSA-C22.2 No.107.1, EN61347-1, EN61347-2-13				
	WITHSTAND VOLTAGE	I/P – O/P: 3.75kVAC, I/P-FG: 2KVAC				
	ISOLATION RESISTANCE	I/P – O/P: 100M Ohms / 500VDC /25°C / 70% RH				
	EMC EMISSION	Compliance to EN55015, EN61000-3-2 Class C (≥60% load); EN61000-3-3				
	EMC IMMUNITY	Compliance to EN61000-4-2,3,4,5,6,8,11; EN61547, EN55024, light industry level (surge 2kV), criteria A				
OTHERS	MTBF	310khrs min. MIL-HDBK-217F (25°C)				
	DIMENSIION	150(177)*65.5*39.5MM(L*W*H)				
	PACKING	745±10g				

NOTE

1. All parameters NOT specially mentioned are measured at 230VAC input, rated load and 25°C of ambient temperature.
2. Ripple & noise are measured at 20MHz of bandwidth by using a 12" twisted pair-wire terminated with a 0.1uf & 47uf parallel capacitor.
3. Tolerance: includes set up tolerance, line regulation & load regulation.
4. Please refer to "DRIVING METHODS OF LED MODULE".
5. Derating may be needed under low input voltages. Please check the static characteristics for details.
6. Suitable for indoor use or outdoor use without direct sunlight exposure. Please avoid immerse in the water over 30 minutes.
7. Length of set up time is measured at cold first start. Turning ON/OFF the power supply may lead to increase of the set up time.
8. The power supply is considered as a component that will be operated in combination with final equipment. Since EMC performance will be affected by the complete installation, the final equipment manufacturers must re-qualify EMC DIRECTIVE on the complete installation again.
9. Direct connecting to LEDs is suggested, but is not suitable for using additional drivers.
10. To fulfill requirements of the latest ERP regulation for lighting fixtures, this LED power supply can only be used behind switch without permanently connected to the mains.

Derating Curve

DERATING CHARACTER

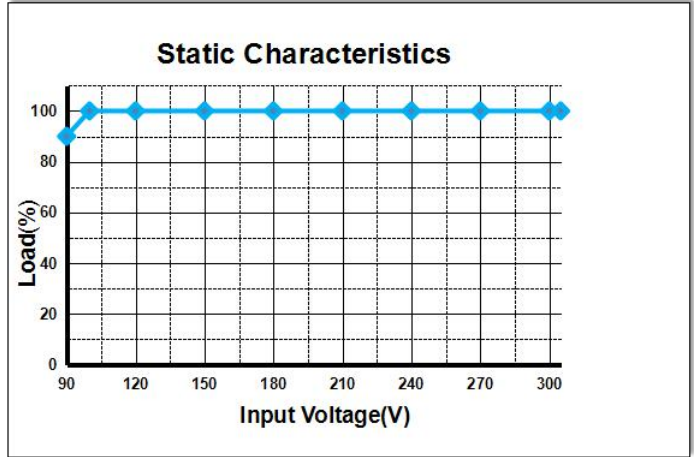
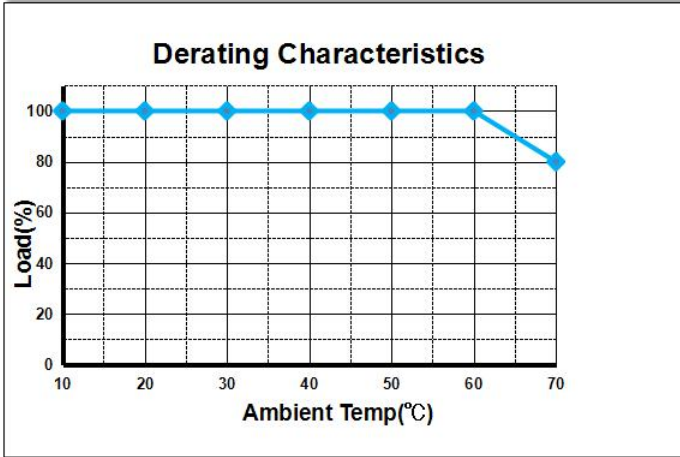

POWER FACTOR CHARACTERS

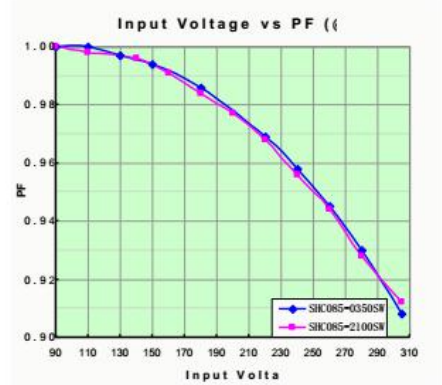
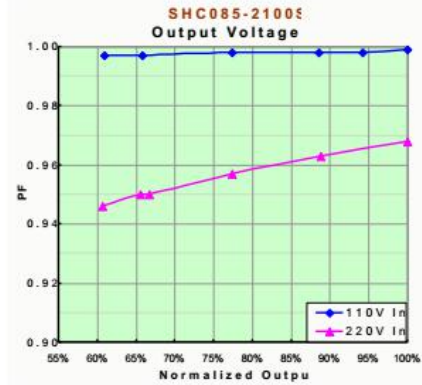
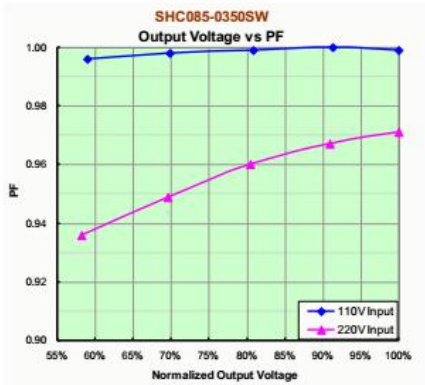

EFFICIENCY vs LOAD

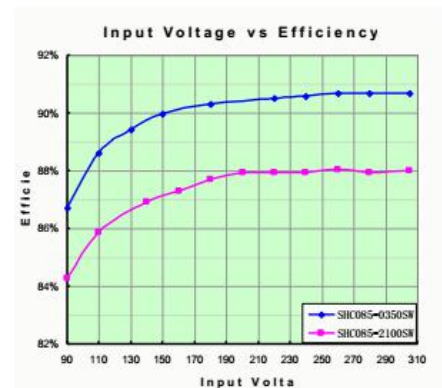
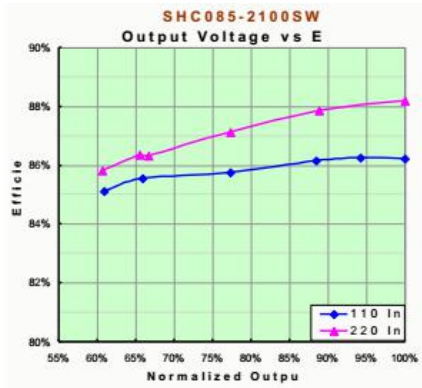
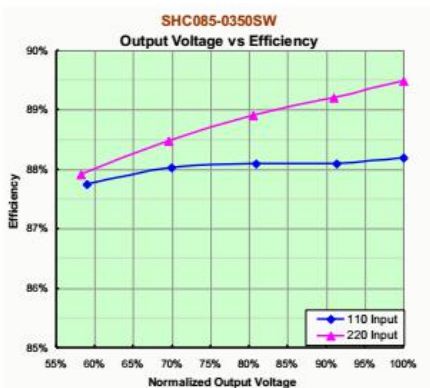

Mechanical Specification

NO or TIMER Dimming Function Mechanical

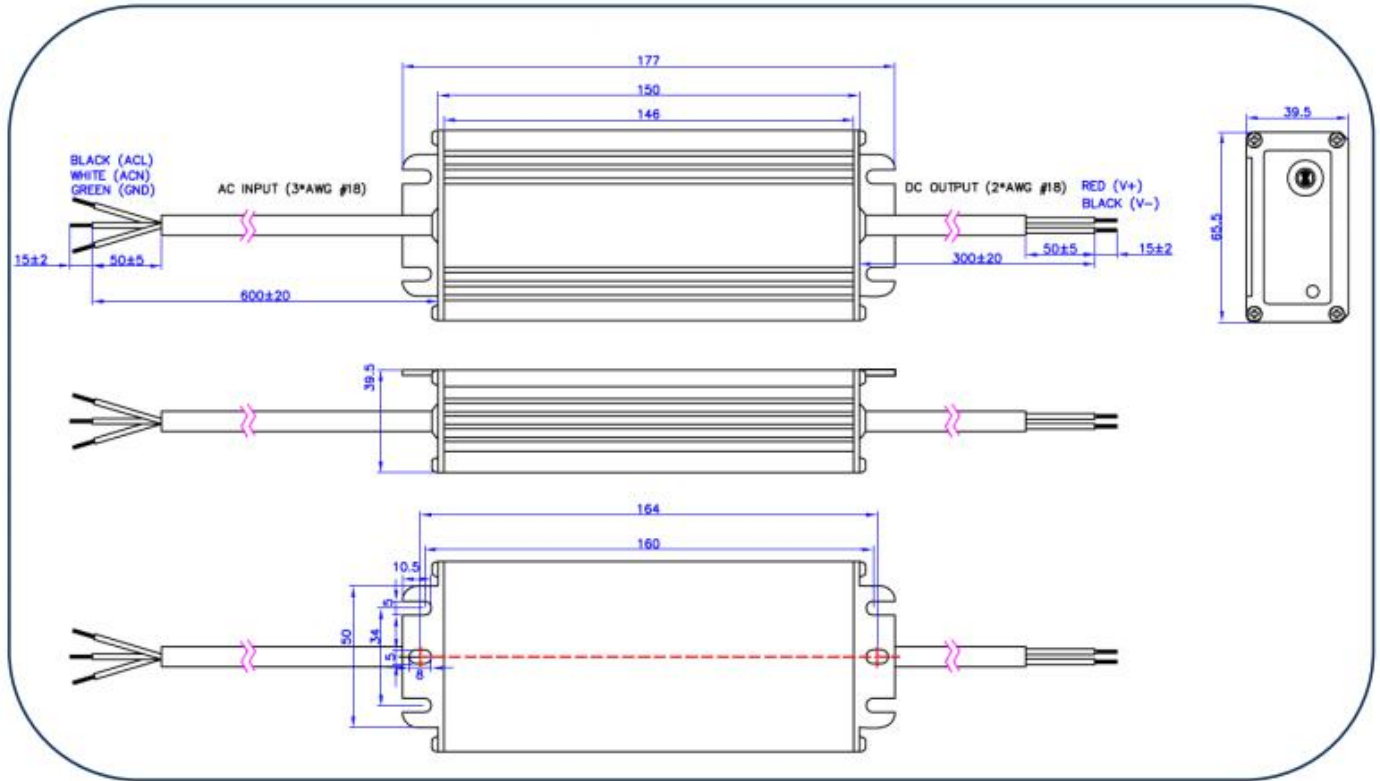

0-10V or PWM Dimming Function Mechanical

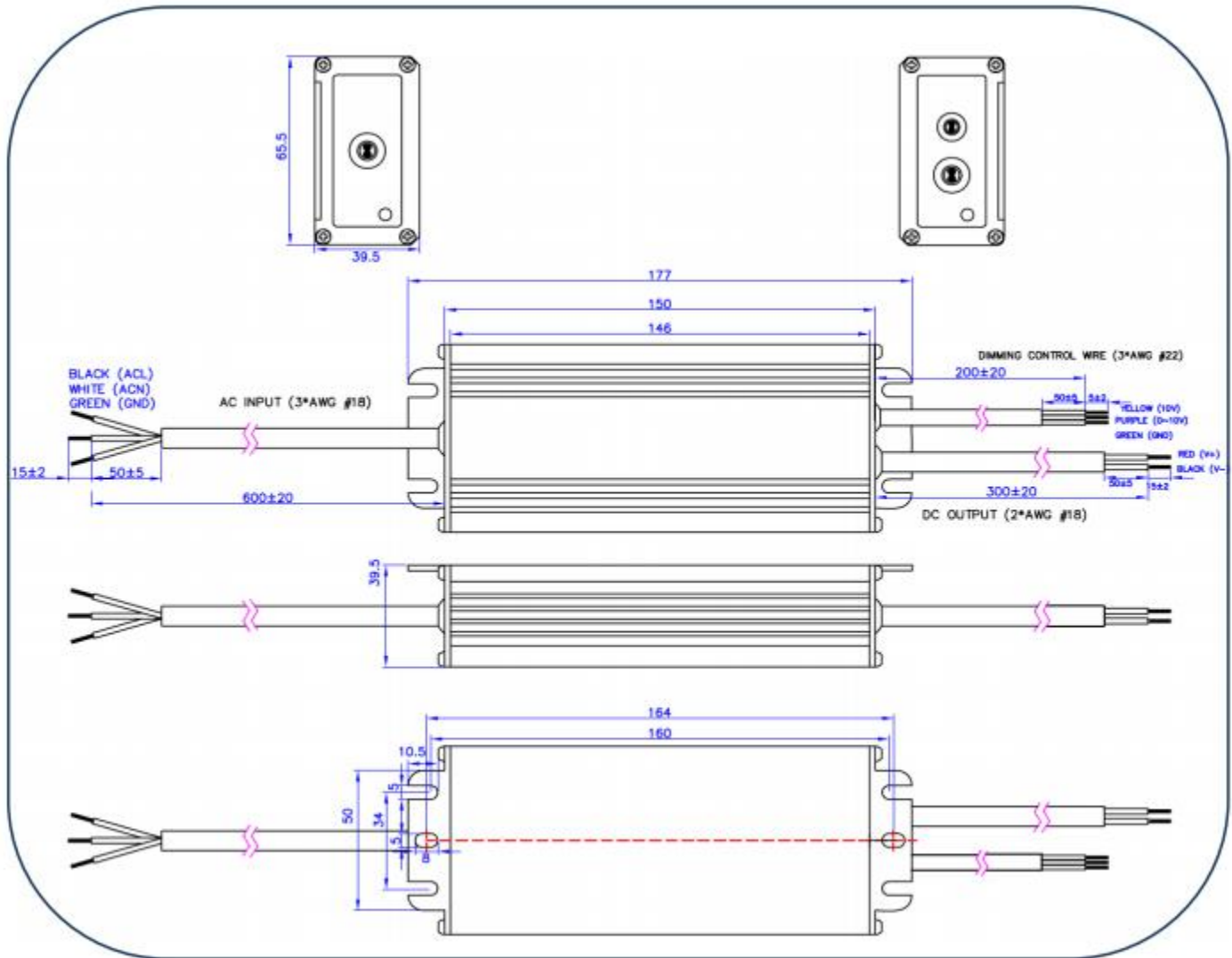

Dimming Function

TIMER Dimming

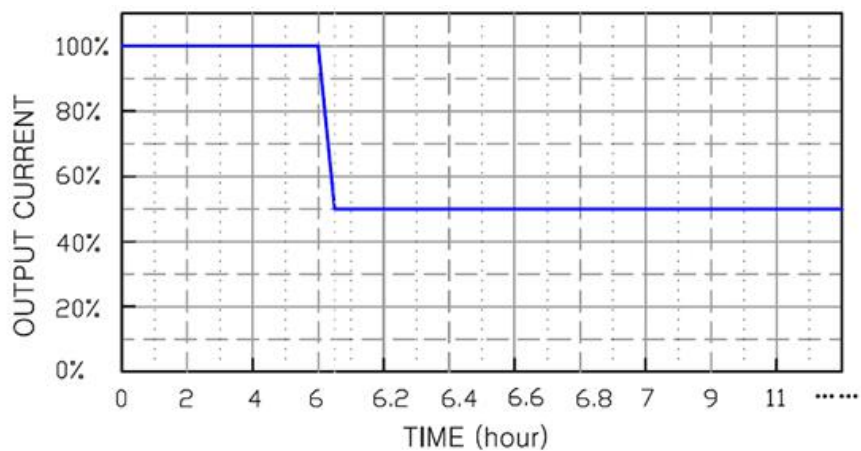

NOTE:

1. The dimming time can be customized according to different orders.

0-10V Analog Dimming

Input Dimming Voltage	0-12V	Normal 10-11V
Input Source Current	0-10mA	47 ~ 63Hz

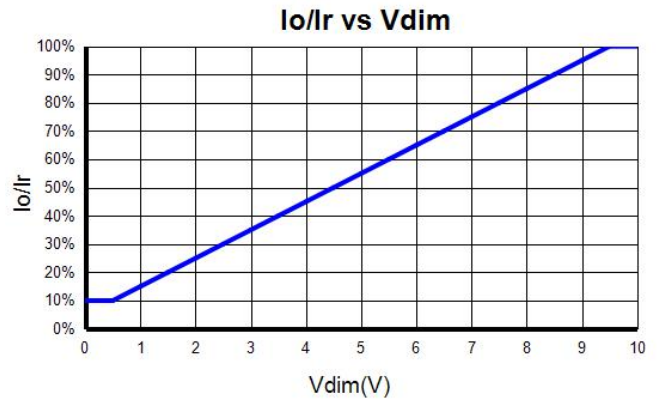

NOTE:

1. If the dimming function is not used, all wire NC.
2. I_o is actual output current and I_r is rated current without dimming control.
3. For the driver to operate properly, the load voltage must be maintained above the input voltage t , proximally 50% of the max. output voltage for any given mode.
4. The dimming signal is allowed to be less than 1V, when it for 0-1V, the connected LEDs may flicker. Keeping dimming voltage greater than 1V in application is strongly recommended.
5. Do not connect the **GND of dimming (gray)** to the output. Otherwise, the LED driver can not work normally.

PWM Dimming

